

**Measurement Equipment
 MS100HU**

Signal-Generator MS100HU

1 General _____

With an appropriate LED adapter the signal generator is used to determine the optical sensitivity or the function of an optical receiver (e.g. Photodiode). It can also be used for attenuation measurements on fiber optic links in combination with an optical power meter. The output of the signal generator is a modulatable current source, which delivers a stabilized optical power output in combination with an LED adapter. The adapter system allows the connection to a quantity of fiber optic cables. The adapters are available in different wavelengths.



Pic. 2 Signal-Generator MS100HU with rubber boot

2 Applications _____

Favourable characteristics plus accurate coupling with all system adapters on terminated optical cable enables the useage of the signal generator to a great number of applications:

- laboratory analysis
- installation inspections
- quality control
- testing of optical receivers
- attenuation readings on optical cable

4 Features _____

- Stabilized current source
- 1, 10, 20 kHz modulation frequency
- BNC-socket
- 9V battery powered or ext. power supply
- 25mm x 50mm LC-Display
- Plastic housing
- Robust rubber boot
- Easy handling

3 Block diagram _____

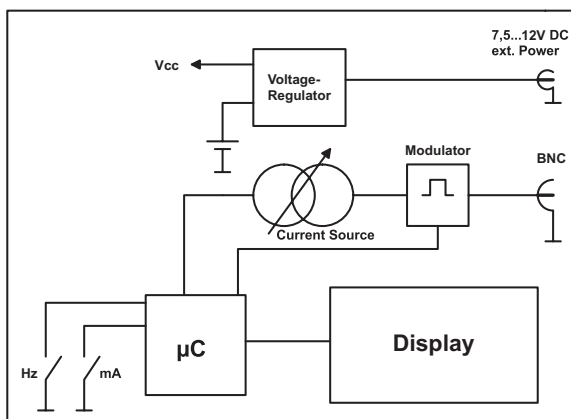

Pic. 1 Block diagram Signal-Generator

5 Odering Information _____

Specification	Part Number
Basic device (no adapters)	909MS00000111

Appropriate adapters for different connector styles and wavelengths must be ordered separately

Note :
 Please refer to data sheets **E09MS660SM001** or **E09MS850SM001** for System Adapters



Signal-Generator MS100HU

6 Operation

Please attach the required adapter to the BNC-socket. Pic. 3 shows the signal generator with the F-ST adapter 909MS660SM001.



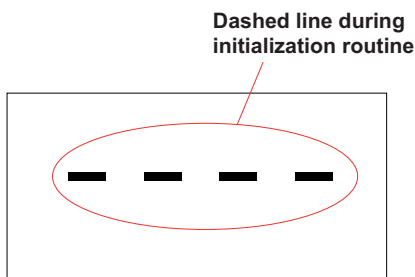

Pic. 3 BNC-socket with F-ST adapter

Press On/Off  button positioned on the left top half of housing. At power up the signal generator starts an initialization. The display signals the progress with a dashed line for a short time.



Pic. 4 Signal generator display, Initialisierung

After initialization, the LC-Display shows the last preset modulation frequency and forward current (Pic. 5).

By operating the keys  and  on the top side of the signal generator the modulation frequency (Hz = DC/1kHz/10kHz/20kHz) as well as the forward current (mA=10mA/20mA/30mA/40mA/50mA) may be toggled.

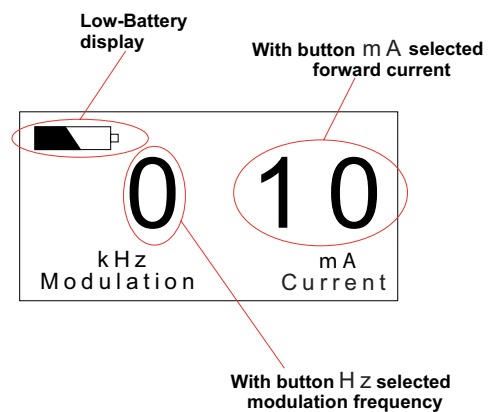

Pic. 5 Signal generator display

If the battery or the external power supply drops below 6.5 V, a warning will be displayed (Low-Battery display).

7 Maximum Ratings

Power supply _____ +12V DC
Output Load _____ min. 10 Ω
Storage temperature _____ -20...+70°C
Operating temperature _____ -10...+60°C

Stresses beyond those listed under 'Maximum Ratings' may cause permanent damage to the instrument. Above listed values are stress limits only and functional operation of the signal generator at these conditions is not recommended. Exposure to maximum rating conditions for extended periods may affect the instrument reliability.



Signal-Generator MS100HU

9 Technical Data _____

10 Technical Drawing _____

signal port: adapter, BNC
for all common FO-
connectors
current output: selectable 10mA
20mA
30mA
40mA
50mA
current modulation: selectable DC
1kHz
10kHz
20kHz
frequency error: max. $\pm 1.5\%$
current error: max. $\pm 1\text{mA}$
temperature drift: 0.01%/°C
power supply: 9V block battery
(t_{Life} appr. 2h)
external 9V DC via
3.5mm socket
current consumption: max. 55mA at $I_F = 20\text{mA}$
case: plastic
dimensions: appr. 128x70x26 mm
(L x W x H)
protection class: IP40
weight: appr. 160g

Dimensions without rubber boot.

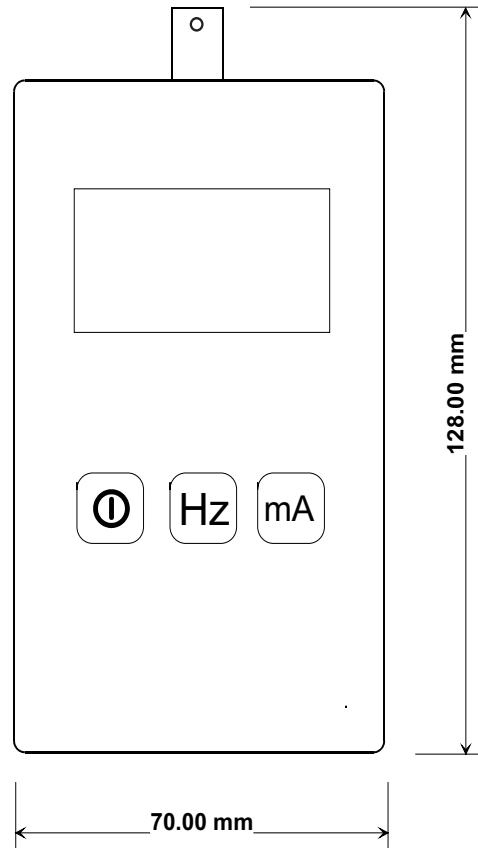

The information released by Ratioplast-Optoelectronics GmbH in this data sheet is believed to be accurate and reliable. However, no responsibility is assumed by Ratioplast-Optoelectronics GmbH for its use. Ratioplast-Optoelectronics GmbH reserves the right to change circuitry and specifications at any time without notification to the customer.